

Canon

4K

CINE-SERVO CN7×17 KAS S



 CINEMA EOS SYSTEM

CINE-SERVO CN7×17 KAS S

New Era, New Concept

Significant changes are taking place at video production sites around the world today. As cinema equipment goes digital, a video creation process that takes full advantage of the characteristics of the large-format cameras (such as shallow depth of field, high sensitivity, low noise, and wide dynamic range), that have been used for conventional cinema applications, is becoming more widespread for broadcast applications such as TV dramas, documentary programs and promotional videos. In response, there is a growing demand for lenses that can achieve excellent optical performance, as well as operability and applicability suitable for shooting when carrying a large-format camera on one shoulder and using broadcast lens standard controllers.

Canon is introducing a new concept lens called CINE-SERVO CN7×17 KAS S to the market. The CN7×17 KAS S was developed by integrating the best aspects of the technologies that the company has acquired through the development of broadcast zoom lenses and EF Cinema Lenses over the years and by further evolving those technologies.

The CN7×17 KAS S offers stunning 4K camera-compatible optical performance and is compact and lightweight, which allows the camera operator to shoot with the camera carried on one shoulder. It is also an extremely innovative lens that features a high magnification of 7x and covers a very broad focal length range of 17mm to 120mm. In addition, the lens can be operated through broadcast lens standard controllers and also used as a cinema lens with full manual operation by detaching the drive unit from the lens.

Canon intends to meet the requirements of broadcast lens users, cinema lens users and a wide range of users involved in video production, by delivering the infinite possibilities of high-grade 4K image expression and comfortable and easy operation.

4K camera-compatible stunning optical performance

The CN7×17 KAS S features high resolution from the center to the perimeter of the image and delivers a high-grade, 4K camera-compatible optical performance throughout the zoom range. The lens makes use of wide-diameter aspherical lenses and other optical material technologies, incorporating with cutting-edge simulation technology to achieve optimal optical configuration and correct various aberrations. Furthermore, the latest coating technology is used to minimize the occurrence of ghosting and flare.

High magnification covering a broad focal length range from wide angle to long focus

The CN7×17 KAS S offers outstanding 4K camera-compatible optical performance and at the same time covers a very broad focal length range of 17mm at the widest angle to 120mm telephoto. With just this lens, you can expand your creative possibilities for image expression.



f=17mm



f=120mm

Imaging Excellence with Optimized Operational Performance

■ Shooting with a camera carried on shoulder

The lens is compact and lightweight, and still can be used with large-format cameras. Since the lens uses a new drive unit and lens barrel with the same size as that of broadcast ENG lenses, it inherits the holding feel of the broadcast lenses (where the distance from the optical axis of the lens to the palm is close), highly preferred by broadcast camera users. Therefore, the lens provides stability in camerawork and does not cause user fatigue even when the camera is carried on one shoulder.

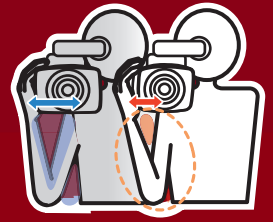

■ Support for standard broadcast lens controllers

The lens enables operation using broadcast lens standard controllers (such as the ZSD-300D and FPD-400D).

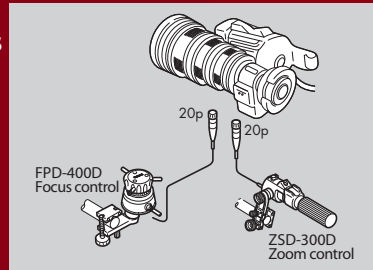

■ Immediate system start-up

The drive unit has a high-performance encoder so that the lens requires no initialization. Since the encoder does not require the initialization operation when the lens is powered on, the system can be started immediately.

■ Support for virtual image data output

The drive unit has three 20-pin connectors and a high-performance encoder which can output 16-bit precision virtual image signals that produce more stunning virtual image.

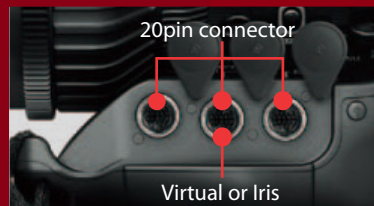

■ Standard broadcast camera interface 12-pin connection cable

The lens is equipped with a 12-pin connection cable, which is the standard interface for broadcast lenses and can be used to supply power to the drive unit and to perform iris remote control etc. (Compatible cameras with 12-pin serial communication.) A system with a camera adapter may require an extension cable EC-120/400.

■ Iris close function

The lens can close the iris completely, which is necessary to calibrate black balance.

■ Operability and functions ideal for broadcast lens users

The lens offers the equivalent servo operation feel as broadcast portable lenses for all focus, zoom, and iris controls. The focus ring is provided with a knurled rubber for superior operability, which allows the equivalent manual operation feel as broadcast portable lenses.



■ Outstanding servo performance

The lens features a high-speed zoom, ensuring that critical moments are never missed. It provides wide-ranging drive speeds and remarkable reproducibility from high to slow speeds, which allows operation just as required by a camera operator.

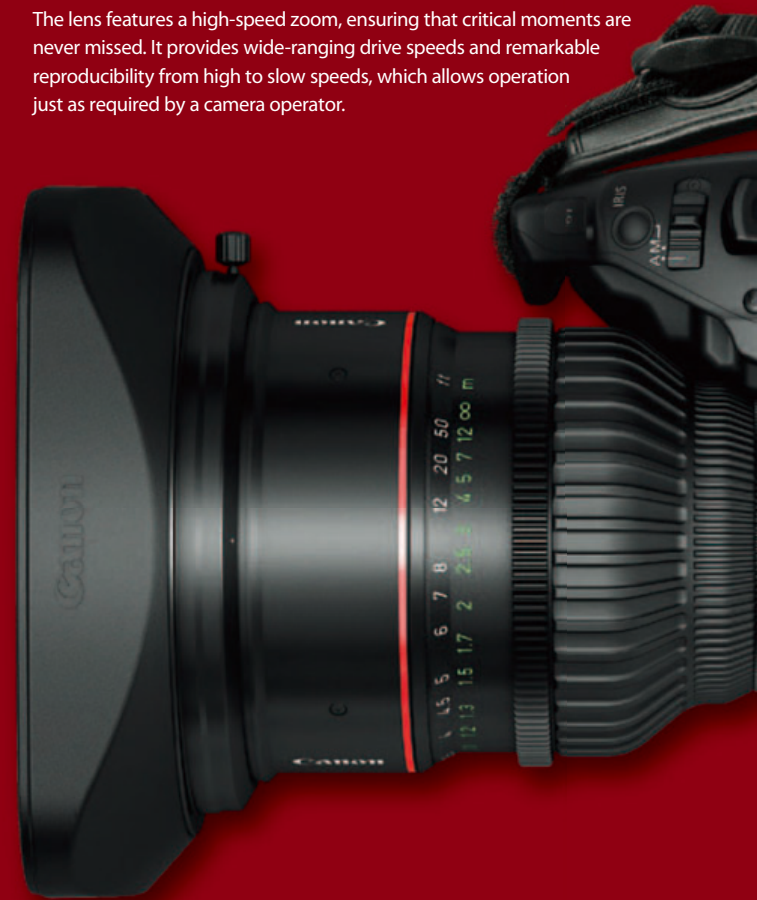

■ Enabled a stable framing by suppressing change of angle of view

The CN7x17 KAS S has adopted the three-group inner focus system (a highly popular system for broadcast lenses and EF cinema lenses) that reduces changes in the angle of view during focusing to assure stable framing at all times.

■ Flange-back adjustment mechanism

The lens enables flange-back adjustment with an operation as easy as that of broadcast ENG lenses.

■ Macro function

The lens enables macro shooting with an operation as easy as that of broadcast ENG lenses.

■ Robustness and durability

The lens features an optimal housing structure made by combining the know-how acquired through the development of Canon broadcast lenses with the latest simulation technologies. The lens provides a robustness and durability that can endure in severe operating environments for broadcast applications.

■ Cinema-style shooting

When the drive unit is detached from the lens, the lens can be used as a cinema-style full manual zoom lens.



■ Compatible with cinema industry standard Super 35mm image sensor



■ Easier-to-read ring markings

- The lens provides focus ring markings on angled surfaces on the lens barrel, which makes it easy to read the focus settings from behind the camera.
- Each ring marking is indicated on both sides of the lens to facilitate operation when the cinema camera users use the lens at a movie shooting location. The ring markings indicated on one side of the barrel are coated with luminous paint so that they can be easily read even in the dark.
- The focus ring markings are indicated both in feet and metric units (ft/m), making it unnecessary to replace the focus ring in order to switch from feet to metric and vice versa.



Focus indicators are marked on the inclined surface.



The focus ring markings are indicated both in feet and metric units(ft/m).

■ Easy-to-understand focal length indications

The focal length is indicated on the side of the lens front barrel. The lens adopts customary "focal length indications" normally used by cinema camera users.



■ Support for cinema industry standard accessories

The lens can be used with standard accessories in the cinema industry, such as a matte box, follow focus gear systems, and electronically operated controllers. The focus ring is equipped with 0.8mm and 0.5mm gear modules and the zoom ring is equipped with a 0.5mm gear module, and these make it possible to use the lens with standard accessories in the cinema industry. (The iris ring is equipped with a 0.4mm gear module.)



■ 15mm- and 19mm-diameter rod systems

The lens is equipped with a support holder for cinema lens support rods that can be used with 15mm- and 19mm-diameter rod systems. An extension shaft (included in the product) is required to use the 19mm-diameter rod system.

■ Compliant with wide-ranging communication standards and with a lens-to-camera communication function for added convenience

- CN7x17 KAS S EF-mount lens communicates via an electrical contact when using with a cameras of CINEMA EOS SYSTEM, which enables effective handling of shooting conditions through storing lens data such as zoom position when that picture was shot, as well as other EF Cinema Lens series (Compact Zoom Lens and Prime Lens series). The EF-mount lens will enable to automatically correct pictures by upgrading firmware of the camera.
- CN7x17 KAS S PL-mount lens is compatible with Cooke's /i Technology, which enables transmission of focus, zoom, and iris position data as well as the lens model name so that the camera and editing equipment can display and store the lens information, which further enhances the convenience factor.
- Furthermore, the lens is provided with the standard 12-pin interface connector that is used in the broadcast industry. Therefore, the lens can perform the same type of communications as conventional broadcast portable lenses, such as transmission of focus, zoom, and iris position data as well as remote-controlled operation of the iris.



■ 11-blade aperture diaphragm

The lens is equipped with multiple blades that make the aperture diaphragm rounder and achieves a soft and natural blur effect. It has also adopted an odd number of blades so that the beams of received light spreads without affecting facing diffraction light each other and creates a soft and elegant beam of light when optimal focus is achieved.



EF Cinema Lens 11 blades



9 blades



6 blades

Canon's proprietary optical technology that realizes high image quality EF cinema lenses*

Aspherical lens manufacturing technology

Spherical lens refracts more in the periphery portions than in the center. For that reason, it is impossible to collect a beam of light at the optimal one point. This is called spherical aberration, and this aberration can be corrected by combining multiple lenses. On the other hands, the aspherical lens can collect the light that passes through both the center portion of the lens and the periphery portion of the lens at one point. The performance obtained by using several spherical lenses can be achieved using a single aspheric lens. Therefore, the number of lenses in the entire lens configuration can be reduced. This technology contributes to a reduction in the size and weight of the lenses and at the same time makes it possible to produce sharp images owing to its outstanding optical performance. Canon produces high-performance aspherical lenses by means of advanced manufacturing technologies such as aspherical surface grinding and glass molding processes.

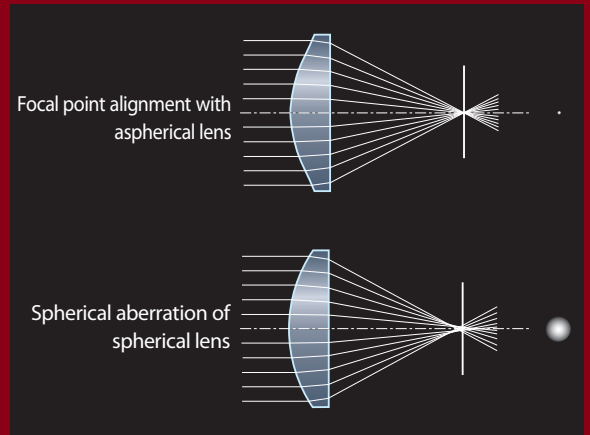

Reducing changes in angle of view to enable stable framing

The CN7x17 KAS S has adopted the inner-focus-type lens formed by a three-lens group, which is a highly proven configuration for broadcast and cinema applications. The lens reduces changes in angle of view that are caused by focusing.

3-group inner focus system established for broadcast and cinema use

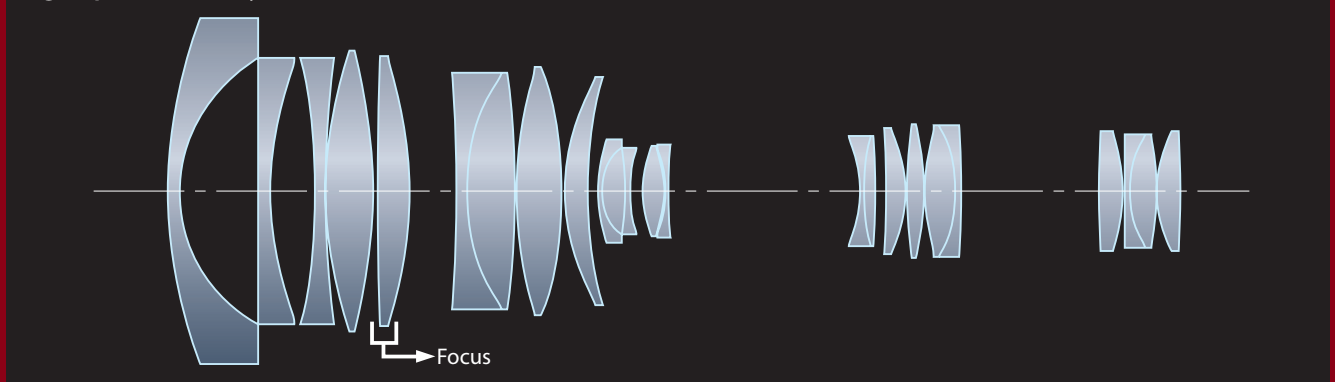

Canon's superb optical material technology

[Fluorite]

In theory, chromatic aberration cannot be completely eliminated in standard optical glass, and a slight chromatic aberration always remains. A material called fluorite (CaF_2) can be used to resolve this problem in optical glass and enables ideal chromatic aberration correction. Fluorite has been known to have an anomalous dispersion characteristic (which optical glasses do not have), which is effective in eliminating chromatic aberration. Fluorite lenses have been used in a number of Canon lenses and effectively correct the chromatic aberration.

[UD and Hi-UD glasses]

The development of glass materials with an anomalous dispersion characteristic similar to fluorite has been progressing recently. These efforts have produced Ultra-low Dispersion (UD) glass. Since UD glass has low dispersion as well as an anomalous dispersion characteristic, effects similar to those of fluorite can be achieved by selecting the proper combination. Furthermore, Hi-UD glass offers high refraction in addition to low and anomalous dispersion characteristics of UD glass, which enables spherical aberration correction as well as chromatic aberration. Hi-UD glass is used for Canon lenses and effectively functions to reduce aberration fluctuation caused by focusing and zooming, in addition to the chromatic aberration that occurs on the telephoto side.

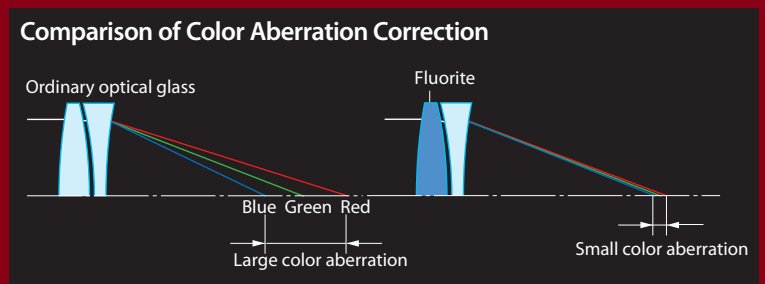

*: Technology applied to the lenses would differ depending on the model.

SPECIFICATIONS

		CN7x17 KAS S/E1	CN7x17 KAS S/P1
Mount		EF	PL
Focal Length		17-120mm	
Zoom Ratio		7×	
Max. Relative Aperture (T-Number)		1:2.95 at 17-91mm 1:3.9 at 120mm	
Iris Blades		11	
Angle of View	1.9:1 26.2 × 13.8mm	75.2° × 44.2° 12.5° × 6.6°	
M.O.D.* (from image sensor)		0.85m / 2.8'	
Object Dimensions at M.O.D.	1.9:1 26.2 × 13.8mm	92.1 × 48.5cm at 17mm 12.7 × 6.7cm at 120mm	
Front Diameter		φ114mm	
Approx. Size (WxHxL)		174.2 × 125.0 × 262.9mm 6.86 × 4.92 × 10.35in.	174.2 × 125.0 × 254.9mm 6.86 × 4.92 × 10.04in.
Approx. Mass		2.9kg (6.39lbs)	
Pitch of Follow Focus Gear		0.8**	

* M.O.D. = Minimum Object Distance

** Pitch of focus gear is also available for cinema accessories.

DIMENSIONS

CN7x17 KAS S/P1

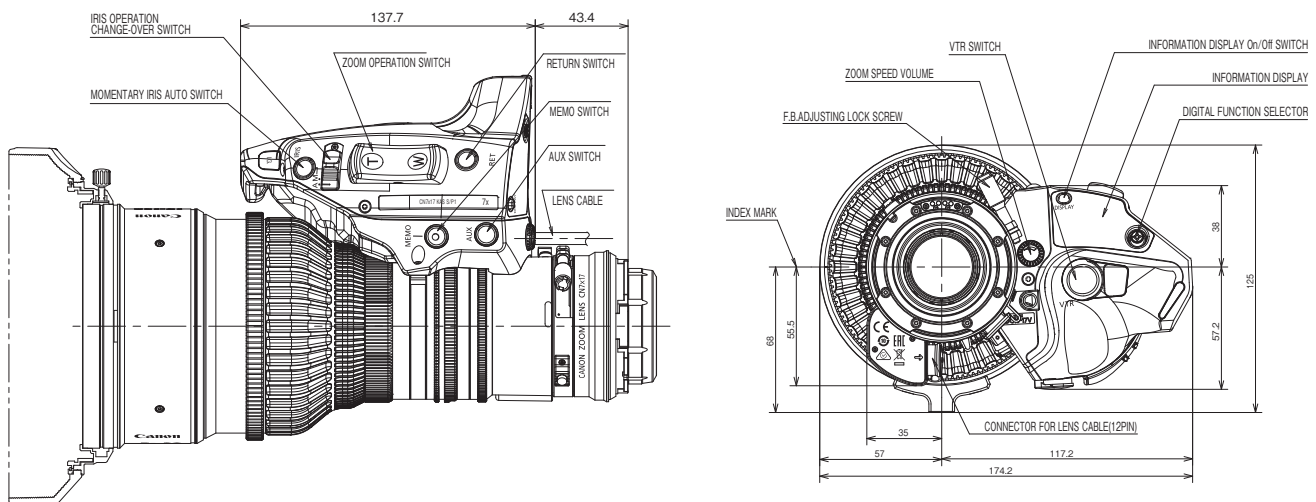

North & South America Canon U.S.A., Inc.

Imaging Technologies & Communications Group
Broadcast and Communications Sales & Marketing
Division(Headquarters)
One Canon Park
Melville, NY 11747-3336
Tel:+1(800)321-4388
Email:bctv@usa.canon.com
<http://www.canonbroadcast.com/>

Chicago

100 Park Blvd. Itasca, IL 60143
Tel:+1(630)250-6236 Fax:+1(630)250-0399

Atlanta

5625 Oakbrook Pkwy. Norcross, GA 30093
Tel:+1(770)849-7890 Fax:+1(770)849-7888

Los Angeles

15955 Alton Parkway Irvine, CA 92618
Tel:+1(949)753-4330 Fax:+1(949)753-4337

Dallas

3200 Regent Blvd. Irving, TX 75063
Tel:+1(972)409-8871 Fax:+1(972)409-8869

Latin America

Tel & Fax:+1(954)757-0980

Mexico

Canon Mexicana S.de R.L. de C.V.
Professional Broadcast & Film Industry Business
Department
Blvd. Manuel Avila Camacho No.138 Col. Lomas
de Chapultepec Mexico 11000 D.F.
Tel:555249 4900 Fax:555249 4901

Canada

Canon Canada, Inc.
Broadcast and Communications Div.
6390 Dixie Road
Mississauga, Ontario, L5T 1P7, Canada
Tel:+1(905)795-2012 Fax:+1(905)795-2140

Europe/Africa/Middle East Canon Europe Ltd

Broadcast products Div.
3 The Square, Stockley Park
Uxbridge Middlesex
United Kingdom UB11 1ET
Tel:+44 (0)20 8588 8140
Fax:+44 (0)20 8588 8603
Email : tvprod@canon-europe.com
<http://www.canon-europe.com/tv-products/>

Australia

Canon Australia Pty. Ltd.
CCI Division
1 Thomas Holt Drive, North Ryde, NSW 2113,
Australia
Tel:+61(0)2-9805-2000

China

Canon (China) Co., Ltd.
Broadcast Equipment Products
15F Jinbao Building No.89 Jinbao Street
Dongcheng District, Beijing 100005, China
Tel:+86-10-8513-9999 Fax:+86-10-8513-9128
<http://www.canon.com.cn>

Canon Hongkong Co., Ltd.

19F The Metropolis Tower, 10 Metropolis Drive,
Hungghom, Kowloon, Hong Kong
Tel:+852-2170-2828
<http://www.canon.com.hk>

Asia/Japan

Canon Inc.
(ICP GROUP 5)
30-2, Shimomaruko 3-chome, Ohta-ku, Tokyo
146-8501, Japan
Tel:+81(0)3-3757-7453 Fax:+81(0)3-3757-7086

Canon Singapore Pte Ltd.

1 HarbourFront Avenue, #04-01 Keppel Bay Tower,
Singapore 098632
Tel:+65-6799-8888
<http://www.canon.com.sg>

Canon Korea Consumer Imaging Inc.

Canon Bldg. 5F, 168-12 Samseong-dong,
Gangnam-gu, Seoul, 135-090, Korea
Tel:+82-2-2191-8500
<http://www.canon-ci.co.kr>